

QuickMatch[®]

High-Capacity Balancer with Vibration Diagnostics

NEW!



HUNTER
Engineering Company

NEW!

QuickMatch® balancer quickly measures runout w

PATENTED

SmartWeight®



- ✓ Odometer tracks savings
- ✓ Minimizes weight usage
- ✓ Maximizes productivity

STANDARD

Bottom-Dead-Center Laser



- ✓ Speeds tape-weight placement
- ✓ Improves accuracy

Printer Option

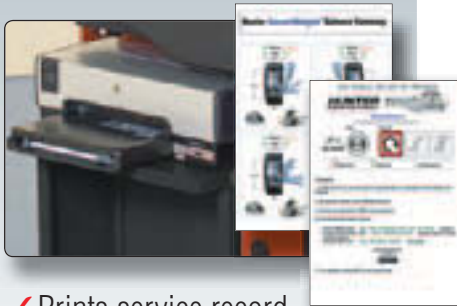

- ✓ Prints service record
- ✓ Sell and perform TPMS work



t with EVERY balance



EXCLUSIVE

Runout Measurement



- ✓ Roller detects high spot of tire
- ✓ Entire contact patch is measured, ensuring accurate results

EXCLUSIVE

TPMSpecs™



- ✓ View reset procedures
- ✓ Updateable database

EXCLUSIVE

HammerHead® Option



- ✓ Speeds clip-weight placement
- ✓ Improves balance

Wheel Lift Option



- ✓ Easily lift wheel assemblies up to 175 lbs
- ✓ Aids proper mounting

PATENTED

CenteringCheck®



- ✓ Ensures proper centering
- ✓ Eliminates setup errors

Balance Cycle Time



- ✓ Fastest floor-to-floor balancing time

QuickMatch® helps eliminate wheel-related vibration

An Unknown Force Vibrates the Spindle...

Customer is upset about strong vehicle vibrations.

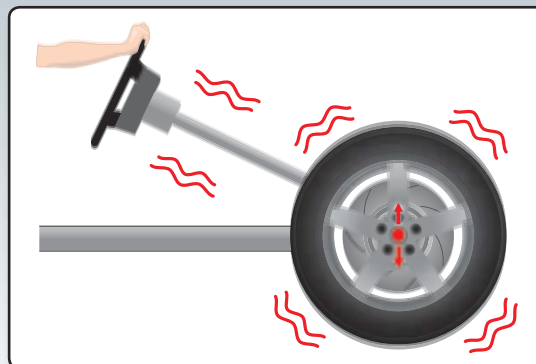

Vibration is transferred from the wheel, through the spindle to the customer.

Specialized Sensors Measure the Assembly



 The QuickMatch balancer quickly measures runout (eccentricity) of a tire and wheel assembly.

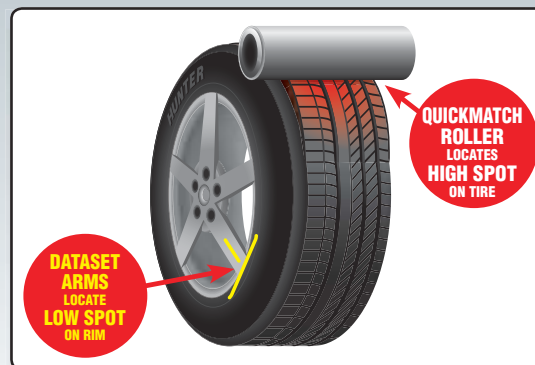

 The roller measures the entire contact patch of the tire, detecting if the assembly is out of round.

Match-Mounting Cancels the Vibration



 Match-mounting the high spot on a tire to the low spot on a rim makes the assembly as round as possible.

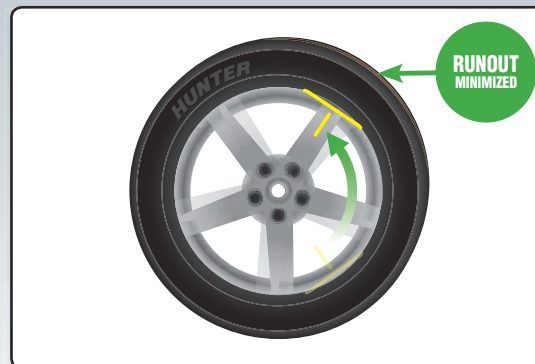

 Runout-related vibration is minimized, ensuring your customer a smoother ride.

EXCLUSIVE

NEW!

TPMSpecs™ brings concise TPMS information to your business!



TPMSpecs pulls together over one hundred OEM TPMS reset procedures into a simple, yet comprehensive, user-friendly tool for the technician.



Save time finding vehicle TPMSpecs



Fast and easy, one-click TPMS access with any bar code scanner! (Scanner sold separately)

TPMSpecs available at check-in too!



As an option, TPMS info can be presented through any internet-connected shop computer!

EXCLUSIVE

Instant on-screen instruction with Hunter Help

Hunter Help offers quick, convenient instruction on a variety of balancing and tire changing topics to help shops provide better service and boost productivity.

- ✓ Covers basic techniques to more advanced procedures
- ✓ Instant access, easy navigation
- ✓ Updatable database

Hunter Help is standard on new Hunter LCD balancers running version 3.1 software and is also available as a software upgrade for existing Hunter LCD balancers.

NEW!





Technicians are guided with helpful tips and time-saving procedures.

Revolutionary **SmartWeight**® by the numbers

PATENTED

SmartWeight Balancing Technology



-  Minimizes weight usage
-  Maximizes productivity
-  Reduces comebacks

4x

Modern vehicles are **4x** more sensitive to static vibration forces than couple or dynamic forces.

30%

SmartWeight can save **30%** or more in correction weights.

2010

California bans lead balancing weights in **2010**, other states are following.

View Your Savings LIVE!



-  Track your weight savings

What this means for you at 10 vehicles per day...

7,130_{oz}

An average shop saves **7,130 oz** per year with SmartWeight.*

25 hours

SmartWeight saves **25 labor hours** per year with efficient weight applications.**

Watch Your Investment Grow

SmartWeight Savings			
Lifetime Savings			
Material Savings:		Labor Savings:	
Ounces:	15,343.5	Minutes:	2,560.2
Pounds:	1,209.0	Hours:	42.7
Boxes (mixed):	635.0		
Savings:	\$6,792.91	Savings:	\$512.05
Total:	\$7,304.96		

-  See weight and labor savings based on **your** shop's numbers

66

Avoid an average of **66 comebacks** per year by using SmartWeight.***

* Calculations based on 10 vehicles per day in a standard working year. Performance differences are those of a SmartWeight-equipped balancer vs. a traditional wheel balancer.

** Timesavings are calculated from comparing single- and no-weight applications when using SmartWeight versus the typical two-weight application of standard balancers.

*** Comeback avoidance is calculated based on residual static imbalance left by standard balancers versus SmartWeight balancers.

Exclusive features make balancing faster and easier



CenteringCheck®

Balancer will tell you if the wheel is properly centered before you proceed with the work.

+ Eliminate the #1 cause of comebacks



Servo Stop Drive Control

Automatically rotates and holds wheel at top-dead-center or bottom-dead-center weight locations.

+ Saves time and increases accuracy



Automatic Mode Detection

Eliminate the need to select the balance mode and reduce service time and possible mode entry errors.

+ No need to push buttons



TranzSaver™

Compares tire circumferences as specified by OEs to prevent damage to AWD vehicles.

+ Prevents costly mistakes

Popular equipment upgrades

Integrated Wheel Lift

- Safely service today's heavy, oversized wheels
- Precisely center all wheels



Color Printer



- Help sell premium service
- Print TPMSpecs procedures



 Available as a field-installed option.

Equipment upgrades *continued...*

EXCLUSIVE

HammerHead® Top-Dead-Center Laser



- Greater weight placement accuracy to avoid mistakes
- More single-spin balances improve productivity and shop profitability
- Overhead fluorescent light illuminates work area



Incorrect



Correct

Specifications*

Power requirements:

196-253V, 10 amp, 50/60 Hz, 1 ph
(Power cable includes: NEMA 20 amp plug, L6-20P)

Capacity:

Rim width: 2.5 in to 20 in (64 mm to 508 mm)
Rim diameter: 10 in to 34 in (254 mm to 864 mm)**
ALU: 7.5 in to 34 in (191 mm to 864 mm)**
Max. tire diameter: 44 in (1118 mm)
Max. tire width: 20 in (508 mm)
Max. assembly weight: 175 lbs (79 kg)

Imbalance resolution: ± 0.05 oz (1.0 g)

Placement accuracy: 512 positions (± 0.7°)

Balancing speed: 290-300 rpm

Motor: Programmable drive system and DC motor

Air requirements (for optional AutoClamp):

100-175 psi (7 ± 12 bar)

Shipping weight: 500 lbs (227 kg)

with wheel lift: 700 lbs (318 kg)

* Some dimensions, capacities and specifications may vary depending on model, accessories and tire and wheel configurations.

** Extreme wheel sizes may require manual data entry.

QuickMatch® Balancer Dimensions†

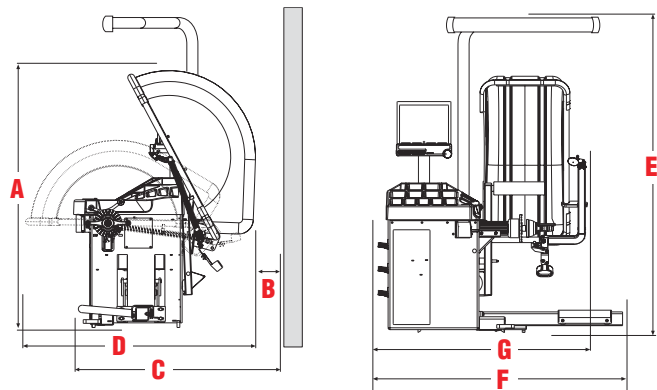

A 73 in (1854 mm)	E 86 in (2184 mm)
B 10 in (254 mm)	F 66 in (1676 mm)
C 61.5 in (1562 mm)	G 56.5 in (1435 mm)
D 62 in (1575 mm)	

† Shown with optional wheel lift and HammerHead features.

Because of continuing technological advancements, specifications, models and options are subject to change without notice.

Be sure to check out other Hunter literature for more quality products from Hunter Engineering.



Cal-Check, CenteringCheck, Dataset, HammerHead, QuickMatch, SmartWeight, TPMSpecs and TranzSaver are trademarks of Hunter Engineering Company.

1110HAP7.5M.33

HUNTER
Engineering Company

www.hunter.com



Available as a field-installed option.

Copyright © 2010 Hunter Engineering Company

Form 5642-T, 11/10
Supersedes 5642-T, 04/10